

ControlMaster CM10

Universal process controller, 1/8 DIN

Making process control easy



Comprehensive display of process status

- Crystal-clear, full-color TFT display
- User-customizable

Exceptionally easy to use

- Intuitive user interface and clear text prompts make installation, commissioning and operation quick and simple

Scalable to match application requirements

- Comprehensive hardware and software options

Flexible control functionality

- On / Off, time proportioning, analog PID and motorized valve control strategies

Problem-solving capability

- Flexible functionality including math and logic providing power to solve application requirements

Built to survive

- IP 66 and NEMA 4X environmental protection

Flexible connectivity

- Ethernet and MODBUS® communications

ControlMaster CM10

Universal process controller, 1/8 DIN

Overview

The ControlMaster CM10 is a flexible, 1/8 DIN, universal PID process controller. Detailed process information is presented clearly on the CM10's full-color TFT display and an intuitive operator interface simplifies configuration and operation.

Scalable in both hardware and software functionality, a CM10 can be specified easily to meet the needs of your application requirements. Flexible control functionality including on / off, time proportioning, analog PID, split output control and math & logic make the CM10 suitable for a wide range of process applications.

Fully configurable via the easy-to-navigate front panel menus or PC configuration software, the CM10 can be commissioned rapidly and then tuned via the advanced autotune functionality.

MODBUS and Ethernet communication options ensure easy integration into a control system.

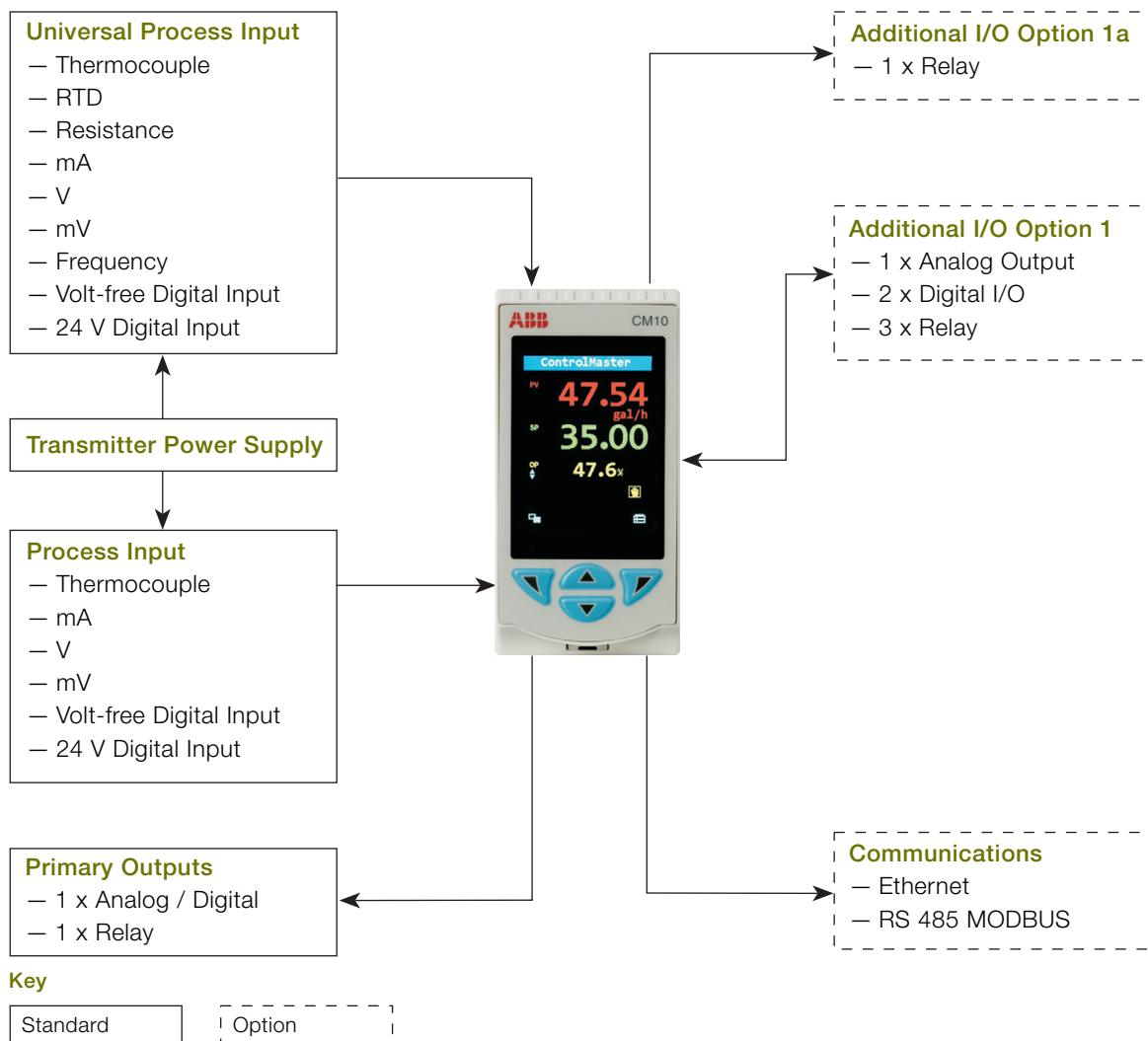

Scalable functionality

The CM10 is scalable in terms of both hardware and software, enabling it to meet your application requirements. The basic CM10 meets the needs of a simple control loop. Additional templates and functionality can be enabled by adding a function key to the basic model as shown in Fig. 1, while retaining previous templates and functionality. For I/O builds, see also Ordering information on page 19.

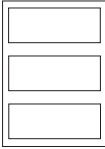
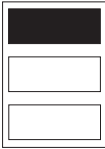
Level	Function Keys	Template	Functionality
Base	0 	Single loop Single loop with remote setpoint	Process alarms Basic setpoint switching Basic control <ul style="list-style-type: none"> – Analog PID – On / Off or time proportioning – Auto tune – Split output control
Standard	1 	Auto / Manual station low signal selection Auto / Manual station digital signal selection * Analog backup station low signal selection Analog backup station digital signal selection * Single indicator / manual loader Dual indicator / manual loader	Standard setpoint switching Standard control <ul style="list-style-type: none"> – Gain scheduling – Motorized valve control † Output tracking Logic Math Custom linearizers Delay timers Real time alarms Template customization

Recommended I/O build:

* Basic + option board 1

† Basic + option board 1a

Fig. 1: Overview of template options

ControlMaster CM10

Universal process controller, 1/8 DIN

Powerful operator display

The CM10 features a full-color 5.5 cm (2.2 in.) display for displaying detailed process information to the user. Process details such as alarm messages and diagnostic information are displayed clearly in full text without the need for difficult-to-read scrolling displays.

Example of an operator page

Automatic selection of standard display templates immediately makes best use of the CM10's display. Extensive customization features then enable the displayed information to be tailored to suit the process requirements.



Fig. 2: Single loop display

Diagnostics and alarm status display

The diagnostics and alarm status display provides detailed information on any active alarm or diagnostic condition. The operator can see, at-a-glance, the status of any alarm condition present within the process. Additionally, diagnostic messages are presented clearly to the operator, enabling rapid notification and simple diagnosis of any critical instrument status condition.

Historical information of diagnostic messages can also be viewed in the controller's diagnostic log.



Fig. 3: Alarm status display

Exceptionally easy to use

The CM10's full-text display and simple-to-navigate, pop-up menu makes operation exceptionally easy.

A programmable soft key enables commonly used functions, such as auto / manual selection, alarm acknowledgement and display selection, to be accessed easily by the operator.



Fig. 4: Pop-up menu

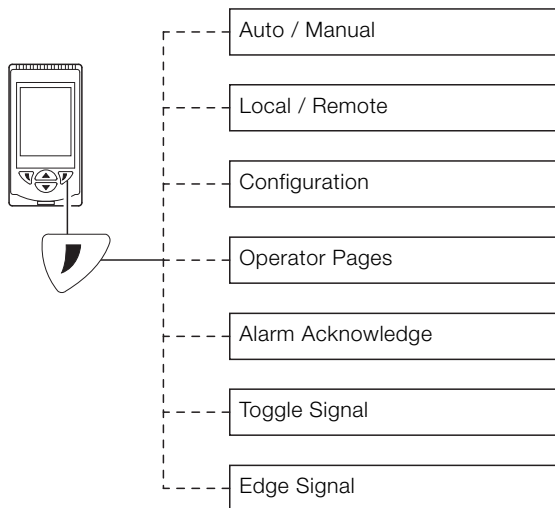

Fig. 5: Programmable soft key

ControlMaster CM10

Universal process controller, 1/8 DIN

Flexible control functionality

The CM10 features flexible control functionality making it suitable for a wide range of applications. Features include:

Autotune

Once initial configuration is complete, a powerful autotune facility enables automatic calculation of the PID values required, enabling rapid commissioning of the CM10.

Gain scheduling

The CM10's gain scheduling functionality is used for efficient control of non-linear processes. Up to 3 different sets of PID parameters are selected automatically from a reference signal ensuring optimum control response, regardless of the process status.

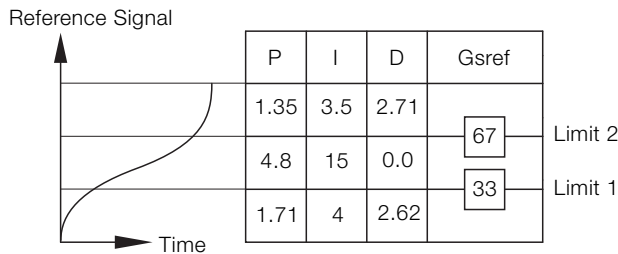

Fig. 6: Gain scheduling example

Split output control

The CM10 can also be configured to perform split output control, for example, when both heating and cooling of a single process is required.

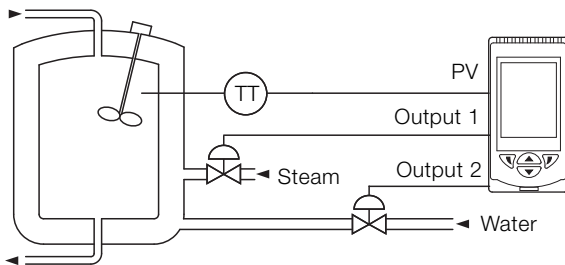

Fig. 7: Split output control example

Remote auto / manual switching

In addition to switching via the front panel, the CM10 can be switched between automatic and manual control mode using an external signal. When switched to manual mode via a digital signal, the value of the control output can be preset, for example, to open a control valve automatically during a cleaning cycle.

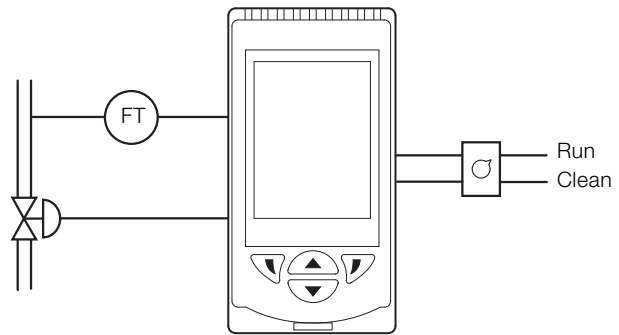

Fig. 8: Remote auto / manual switching

External setpoint selection

The CM10's control setpoint can be selected via external digital signals, for example, simplifying operation by selecting different setpoints using external push buttons.

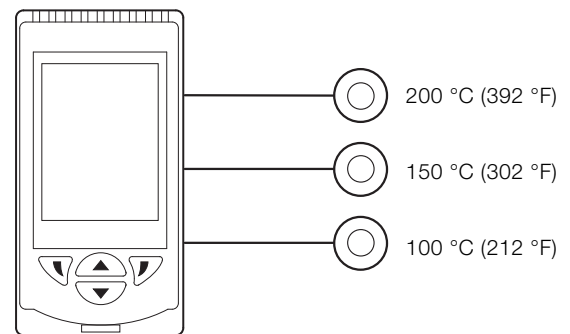

Fig. 9: External setpoint selection

Problem solving flexibility

Extensive functionality is available to provide flexible problem-solving capability; making the CM10 much more than just a process controller.

Process alarms

8 independent process alarms can monitor any analog signal within the CM10, enabling extensive process monitoring capability. Alarms can be used to drive physical outputs or soft-wired to other functions within the controller.

Real-time alarms

The 'alarm clock' functionality provided by the CM10's real-time alarms enables time-of-day decisions to be introduced into the controller's actions or specific functions to be triggered routinely at specified times.

Delay timers

Event sequencing is enabled through the use of the CM10's delay timers. A predetermined delay and output duration can be programmed into each delay timer and timers can be linked together.

Custom linearizers

The CM10 has 2 independent 20-point custom linearizers that can be applied to any analog signal within the controller. These linearizers can be used in applications such as level-to-volume conversion of a non-linear tank level or to accommodate special input signals or output devices.

Math

8 math blocks provide arithmetic, averaging, min. / max. hold, square root and signal switching functionality. Simple equations can be performed in a single math block or multiple math blocks can be nested together to construct complex equations.

Signal switching 'multiplexer' math blocks switch between 2 analog signals based on a trigger signal. For example, a backup sensor could be selected automatically on failure of a primary sensor.

Logic

8 comprehensive logic equations provide powerful interlock functionality. Inputs and outputs of the logic equations can be soft-wired to any digital signal within the controller to maximize flexibility.

ControlMaster CM10

Universal process controller, 1/8 DIN

Communications

Extensive communication options enable the CM10 to be integrated into larger control systems easily or connected to other process instrumentation.

Ethernet

Optional Ethernet communications enable ControlMaster to be integrated in to an Ethernet network quickly. The following functionality is provided:

– Email

Notification of a critical process event or status can be made by email. Multiple events can trigger an email that can be sent to multiple recipients

– Webserver

ControlMaster's integrated webserver enables the current status of the process and controller to be viewed remotely using a standard web browser

– MODBUS TCP

Process values and status can be communicated to and from the CM10 in real-time using MODBUS TCP, enabling it to be integrated easily into larger control systems or connected to a data recorder.

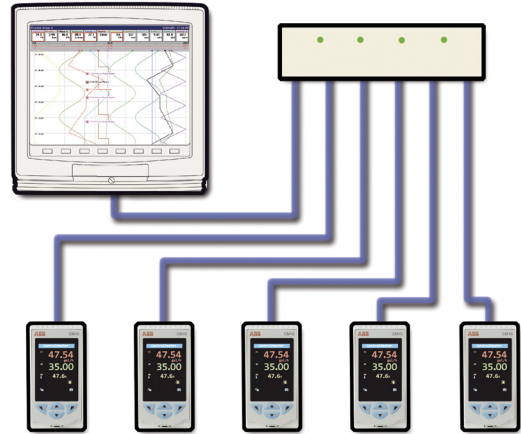

Fig. 11: ControlMasters connected to a ScreenMaster

RS 485 MODBUS

Using RS 485 MODBUS, values and status can be communicated to and from the controller in real-time via an RS 485 connection.

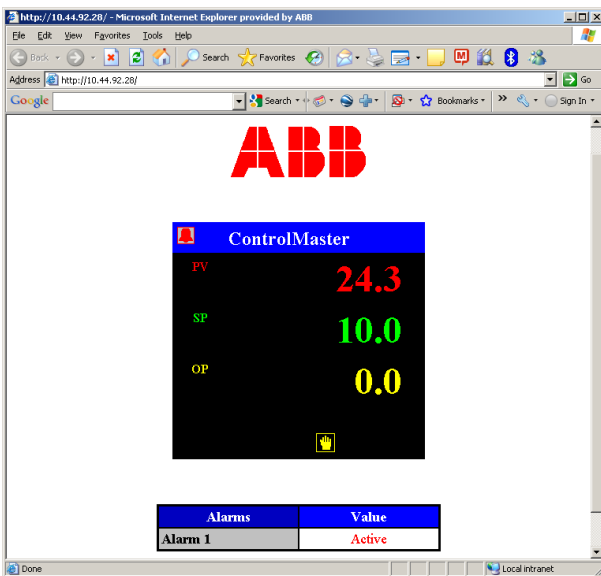

Fig. 10: Webserver

PC configuration

In addition to configuration via the front panel, the CM10 can be configured offline using ABB's Asset Vision Basic, a Device Type Manager (DTM)-based configuration package.

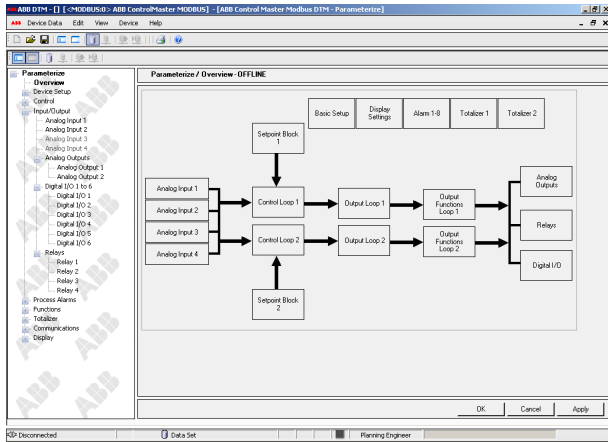

Fig. 12: PC Configuration software

Configuration files can be stored locally on a PC and transferred to the controller via its front panel infrared port.

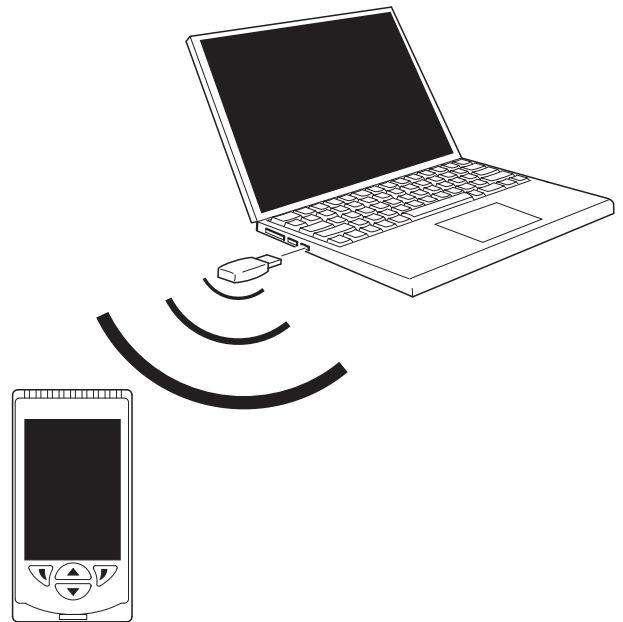

Fig. 13: Transferring a configuration file via the infrared port

PC configuration software for ControlMaster is available for download from www.abb.com/instrumentation.

ControlMaster CM10

Universal process controller, 1/8 DIN

Application templates

To minimize commissioning time, the CM10 features up to 8 preconfigured control strategy templates. By selecting the required control strategy, the template configures the CM10's function blocks and display automatically. Customization of the preconfigured templates is also possible, providing the flexibility to create customized solutions.

Single loop

This template provides standard, single loop process control and is available with or without a remote setpoint.

In this example, the temperature of a product heated by a heat exchanger is regulated via the control of the steam feed to the heat exchanger.

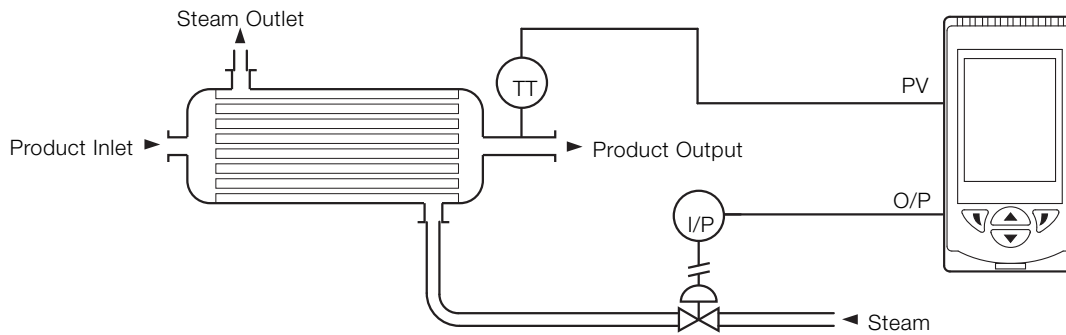

Fig. 14: Single loop

Auto / Manual station and analog backup station

These templates configure the CM10 to backup a master controller, typically a PLC or DCS. A fault condition is detected via a low output signal from the master controller or a digital signal. On detection of a fault signal, the CM10 can take control of the process (analog backup template), freeze its output or switch to a safe output (auto / manual station template). In this example, a critical control of flow is backed-up by the CM10.

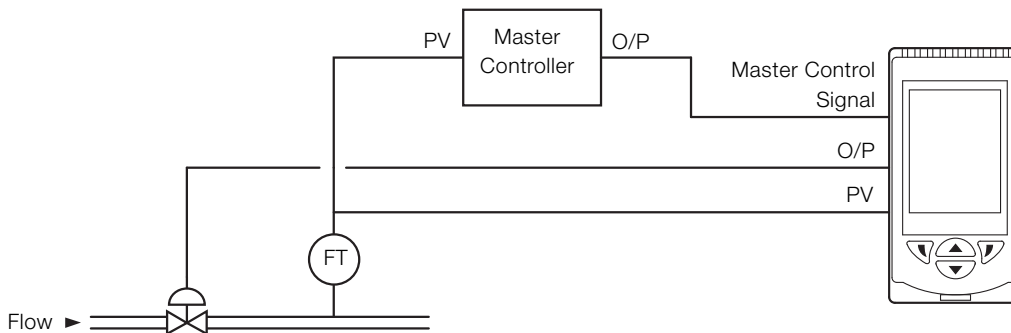

Fig. 15: Auto / Manual station and analog backup station

Technical specification

Operation

Display

Color, 1/4 VGA TFT, liquid crystal display (LCD) with built-in backlight

Language

English, German, French, Italian and Spanish

Operator keypad

4 tactile membrane keys

Security

Password protection

Basic / Advanced – user-assigned password protection (not set at factory)

Standard functions

Base templates:

- Single loop with local setpoint
- Single loop with remote setpoint

Standard templates:

- Auto / Manual station (low signal detection)
- Auto / Manual station (digital signal selection)
- Analog backup station (low signal detection)
- Analog backup station (digital signal detection)
- Single indicator / manual loader station
- Dual indicator / manual loader station

Control output types

Current proportioning

Time proportioning

On / Off

Motorized valve with feedback

Motorized valve without feedback

Split output – with combinations of relay, digital output and current outputs

Control parameters

Proportional band: *

- 0.0 to 999.9 s

Integral: *

- 0 to 10000 s

Derivative: *

- 0.0 to 999.9 s

Manual Reset:

- 0.0 to 100.0 %

* 3 sets of PID parameters when used with Gain Scheduling facility

ControlMaster CM10

Universal process controller, 1/8 DIN

Setpoints

Local:

- 2, selectable via digital input or front panel

Remote:

- selectable via digital input or front panel keys

Auto tune

On-demand calculation of control settings

Process alarms

Number:

- 8

Types:

- High / Low process
- High / Low latch

Source

- Fully configurable
(for example – PV, Analog input, Math block inbuilt, OP control loop deviation)

Hysteresis:

- Level and time

Alarm enable:

- Enable / Disable individual alarms via a digital signal

Acknowledgement

Via front panel keys or digital signals

Real-time alarms

Number:

- 2

Programmable:

- Time
- Day
- Duration

Math blocks

Number:

- 8

Operators:

- +, -, x, /
- Average, Maximum, Minimum
- High / Low / Median select
- Square root
- Multiplexer

Delay timers

Number:

- 2

Programmable:

- Delay
- Duration

Logic equations

Number:

- 8

Elements:

- 15 per equation

Operators:

- OR, AND, NOR, NAND, NOT, EXOR

Custom linearizer

Number:

- 2

Elements:

- 20 breakpoints

Analog inputs

Universal process inputs

Number:

- 1 standard

Type:

- Voltage
- Current
- Resistance (ohms)
- 3-Wire RTD
- Thermocouple
- Digital volt-free
- Digital 24 V
- Frequency
- Pulse

Non-universal process inputs

Number:

- 1 standard

Type:

- Voltage
- Current
- Thermocouple *
- Digital volt-free
- Digital 24 V

Thermocouple types

B, E, J, K, L, N, R, S, T

Resistance thermometer

Pt100

Other linearizations

\sqrt{x} , $x^{3/2}$, $x^{5/2}$

Digital filter

Programmable 0 to 60 s

Display range

–9999 to 99999

Update rate

125 ms

Common mode noise rejection

> 120 dB at 50 / 60 Hz with 300 Ω imbalance resistance

Normal (series) mode noise rejection

> 60 dB at 50 / 60 Hz

CJC rejection ratio

Stability:

- 0.05 $^{\circ}\text{C}/^{\circ}\text{C}$ change in ambient temperature

Temperature stability

0.02 $\%/^{\circ}\text{C}$ or 2 $\mu\text{V}/^{\circ}\text{C}$ (1 $\mu\text{V}/^{\circ}\text{F}$)

Long term (input) drift

< 0.1 % of reading or 10 μV annually

Input impedance

> 10 $\text{M}\Omega$ (mV input)

10 Ω (mA input)

* Only if universal process input is configured as 'Thermocouple'

ControlMaster CM10

Universal process controller, 1/8 DIN

Inputs

Thermocouple	Maximum range °C (°F)	Accuracy (% of reading)
B	-18 to 1800 (0 to 3270)	0.1 % or ± 2 °C (3.6 °F) (above 200 °C [392 °F]) *
E	-100 to 900 (-140 to 1650)	0.1 % or ± 0.5 °C (0.9 °F)
J	-100 to 900 (-140 to 1650)	0.1 % or ± 0.5 °C (0.9 °F)
K	-100 to 1300 (-140 to 2350)	0.1 % or ± 0.5 °C (0.9 °F)
L	-100 to 900 (-140 to 1650)	0.1 % or ± 1.5 °C (2.7 °F)
N	-200 to 1300 (-325 to 2350)	0.1 % or ± 0.5 °C (0.9 °F)
R	-18 to 1700 (0 to 3000)	0.1 % or ± 1 °C (1.8 °F) (above 300 °C [540 °F]) *
S	-18 to 1700 (0 to 3000)	0.1 % or ± 1 °C (1.8 °F) (above 200 °C [392 °F]) *
T	-250 to 300 (-400 to 550)	0.1 % or ± 0.5 °C (0.9 °F) (above -150 °C [-238 °F]) *

* Accuracy is not guaranteed at temperatures below this value

RTD	Maximum range °C (°F)	Accuracy (% of reading)
Pt100	-200 to 600 (-325 to 1100)	0.1 % or ± 0.5 °C (0.9 °F)

Linear inputs	Standard analog input	Accuracy (% of reading)
Millivolts	0 to 150 mV	0.1 % or ± 20 μ V
Milliamps	0 to 50 mA	0.2 % or ± 4 μ A
Volts	0 to 25 V	0.2 % or ± 20 mV
Resistance (low)	0 to 550 Ω	0.2 % or ± 0.1 Ω
Resistance (high)	0 to 10 k Ω	0.5 % or ± 10 Ω
Sample Interval	125 ms per sample	

Digital inputs

Type	Volt-free or 24 V
Minimum pulse duration	Single input configured – 250 ms Both inputs configured as analog or digital – 500 ms

Frequency input*	
Frequency range	0 to 6000 Hz
1-signal	15 to 30 V
0-signal	-3 to 5 V

*For use with devices with open collector outputs

Outputs

Controls / Retransmission outputs

Number:

– 2 (1 standard, 1 optional)

Type:

– Configurable as analog or digital pulse

Isolation:

– Galvanically isolated from the rest of the circuitry,
500 V for 1 minute

Analog range:

– 0 to 20 mA programmable

Load:

– 750 Ω max.

Accuracy:

– 0.2 % of output or ± 10 μ A

Relays

Number:

- 4 (1 standard, 3 optional)

Type:

- Standard with changeover contacts
- Optional contacts selectable as NO or NC (by jumper)

Relay 1 contact rating:

- 5 A, 240 V

Relay 2, 3 and 4 contact ratings at maximum ambient temperature of 40 °C (104 °F):

- 5 A, 240 V

Relay 2, 3 and 4 contact ratings at maximum ambient temperature of 55 °C (131 °F):

- 2 A, 240 V

Update rate:

- 125 ms

Digital I/O

Number:

- 2 (optional)

Type:

- User-programmable as input or output
- Minimum input pulse duration – 125 ms

Input:

- Volt-free or 24 V DC
- 1-signal 15 to 30 V
- 0-signal –3 to 5 V
- Conforms to IEC 61131-2

Output:

- Open collector output
- 30 V, 100 mA max. switched
- Conforms to IEC 61131-2

Update rate:

- 125 ms

2-Wire transmitter power supply

Number:

- 1 standard

Voltage:

- 24 V DC

Drive:

- 2 loops, 45 mA max.

ControlMaster CM10

Universal process controller, 1/8 DIN

Communications

Note. Only one communications option can be fitted per controller.

IrDA service port (standard)

Baud rate:

- Up to 115 kBaud

Distance:

- Up to 1 m (3 ft)

Functions:

- Firmware upgrade
- Configuration upload / download

Ethernet (optional)

Type:

- 10BaseT

Connector:

- RJ 45

Protocols:

- TCP/IP
- HTTP
- MODBUS TCP (Slave)

Web server:

- Built-in – enables remote monitoring using standard web browsers

Email

- Can be configured to be sent on the occurrence of a specified event
- Up to 3 recipients
- Up to 4 trigger sources with configurable tag

MODBUS * RTU (optional)

Baud rate:

- Up to 115 kBaud

Isolation:

- Galvanically isolated from the rest of the circuitry, 500 V DC for 1 minute

* MODBUS is a registered trademark of the MODBUS-IDA organization

EMC

Emissions & immunity

Meets requirements of IEC 61326 for an Industrial Environment

Environmental

Operating temperature range

0 to 55 °C (32 to 131 °F) *

Operating humidity range

5 to 95 % RH (non-condensing)

Storage temperature range

-20 to 70 °C (-4 to 158 °F)

Enclosure sealing

Front face:

— IP 66 & NEMA 4X

Rest of enclosure:

— IP 20

Vibration

Conforms to EN60068-2-6

Safety

Approvals and certifications

EN 61010-1

cULus

General safety

Pollution category 2

Insulation category 2

Isolation

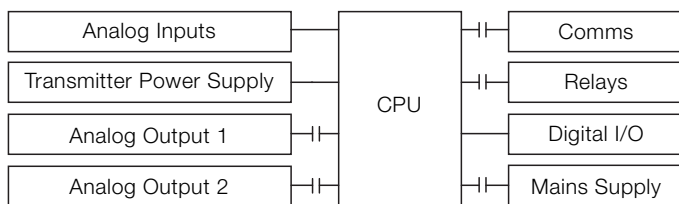

Key

—||— = Isolation

Electrical

Supply ranges

100 V to 240 V AC $\pm 10\%$ (90 V min. to 264 V max.) 50 / 60 Hz
10 to 36 V DC (optional)

Power consumption

10 W max.

Power interruption protection

No effect for interrupts of up to 60 ms

Physical

Size

50 x 97 x 141 mm (2.0 x 3.8 x 5.5 in.)

Weight

0.38 kg (0.84 lb) approx. (unpacked)

Panel cutout

45 x 92 (1.8 x 3.6 in.), 121 mm (4.8 in.) behind panel

Case material

Glass-filled polycarbonate

* Restrictions may apply – refer to relay specification on page 15

ControlMaster CM10

Universal process controller, 1/8 DIN

Electrical connections

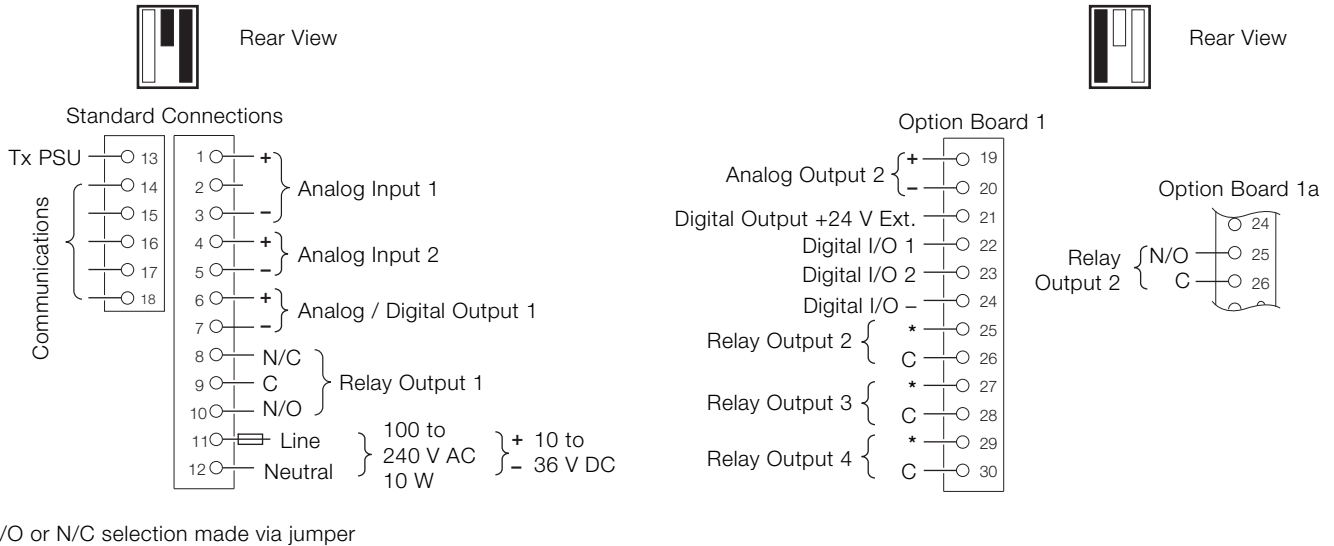

Overall dimensions

Dimensions in mm (in.)

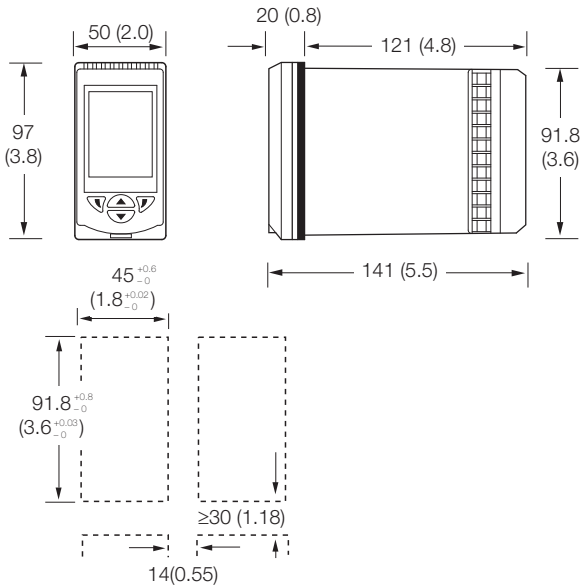

Standard accessories

Included with each controller:

- Panel mounting clamps
- Instruction manual
- Bezel release tool
- Cold junction thermistor

Optional accessories

- PC configuration kit CM30/0712
- CM10/CM15 DIN rail mounting kit CM10/0715

Ordering information

Controlmaster CM10 universal process controller, 1/8 DIN	CM10/	X	X	X	X	X	X	X	/XXX
I/O build									
2 analog inputs, 1 analog O/P and 1 relay (Basic)		0							
2 analog inputs, 1 analog output and 2 relays (Basic + option board 1a)		1							
2 analog inputs, 2 analog outputs, 2 digital I/O and 4 relays (Basic + option board 1)		2							
Template / functionality level									
Base			0						
Standard			S						
Communications									
None				0					
Ethernet				E					
RS 485 MODBUS				M					
Approval									
Standard CE					S				
cULus approval					U				
Power supply									
100 ... 240 V AC						0			
10 ... 36 V DC						1			
Language									
English							E		
German							G		
French							F		
Italian							I		
Spanish							S		
Special features									
None									0
Unbranded front panel									B
Configuration									
Standard									STD
Custom programming									CUS

Contact us

ABB Limited

Process Automation

Howard Road

St. Neots

Cambridgeshire PE19 8EU

UK

Tel: +44 (0)1480 475321

Fax: +44 (0)1480 217948

ABB Inc.

Process Automation

125 E. County Line Road

Warminster

PA 18974

USA

Tel: +1 215 674 6000

Fax: +1 215 674 7183

www.abb.com

Note

We reserve the right to make technical changes or modify the contents of this document without prior notice. With regard to purchase orders, the agreed particulars shall prevail. ABB does not accept any responsibility whatsoever for potential errors or possible lack of information in this document.

We reserve all rights in this document and in the subject matter and illustrations contained therein. Any reproduction, disclosure to third parties or utilization of its contents in whole or in parts – is forbidden without prior written consent of ABB.

Copyright© 2011 ABB

All rights reserved

3KXC401001R1001